

## Questyle QP1R's New Function-USB DAC

With the USB DAC function, the QP1R is recognized as a USB D/A Converter/Pre-amp. The QP1R can now play music from your PC through USB to the QP1R which will allow users to achieve excellent sound performance.

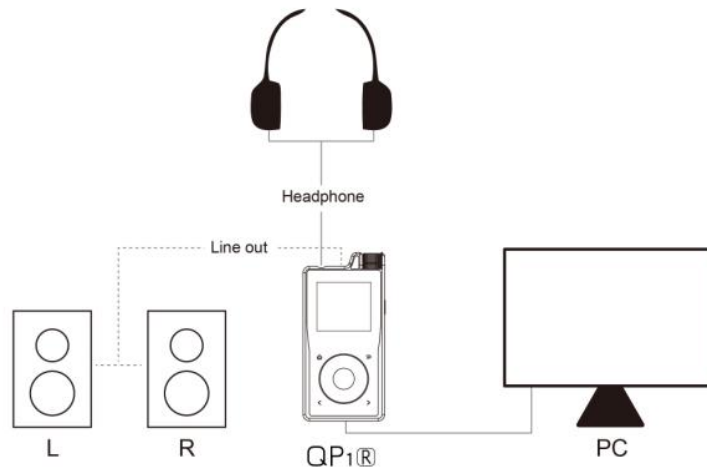

### How to Use:

- 1) Click system menu→USB Settings→choose “DAC” mode;
- 2) Connect QP1R and PC by USB cable;
- 3) If your PC is Windows OS, please download Driver Program before use; If your PC is OS, without installation.
- 4) Play music on PC(When the music is DSD format, please use professional media play soft ).

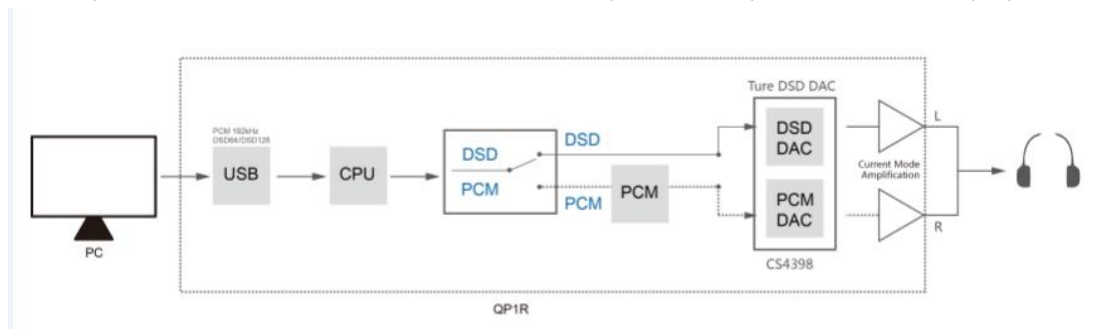

### PC System Requirements

- 1) Opreaion System  
QP1R's driver and hardware support Win XP/Vista/Win8/Win8.1/Win10. For Apple Mac OS, later versions than the 10.5.7 are well matched without installing any driver.
- 2) Media Plaer  
QP1R is not limited to any special media player. Any PC compatible player(including video players) is well matched.
- 3) File Format  
File format is up to the media player on your PC. QP1R can decode any file format that the media player supports.
- 4) Requirements for PC Configuration  
At least one USB port is required. An acceptable USB 2.0 high-speed cable of type A-to-B plug.

We suggest using the high-quality USB cable to ensure the stability and reliability of data transmission and guarantee the best performance of QP1R.

#### Install Driver Program on Windows OS

Your QP1R can be recognized by PC after installing the QP1R Driver on Windows OS. We take Win7 64bit OS for an example to show the Driver installation.

- 1) Connect your QP1R to its power supply and switch it on;
- 2) Connect your QP1R to PC with a USB cable;
- 3) Insert the provided Driver disc into your PC and open the folder labeled "QP1R Driver/For

Windows 7, 8, 8.1 and 10/" and then double click "Setup.exe".



- 4) Then follow the steps below: Click " Next" → " Install" (Default install location is C drive) → " Next" → Finish. Installation will take 3 or 5 minutes.

- 5) Restart your PC and the QP1R Driver is finished installation;

- 6) Installation on Win XP, Vista is similar to the above.

#### Setup DSD on Jriver Media Center

- 1) Connect your QP1R to its power supply and switch it on;
- 2) Connect your QP1R to PC with a USB cable;
- 3) Open Jriver Media Center, click "Tools" and then select "Options";
- 4) Select "Questyle ASIO Driver[ASIO]" under "Audio Device";

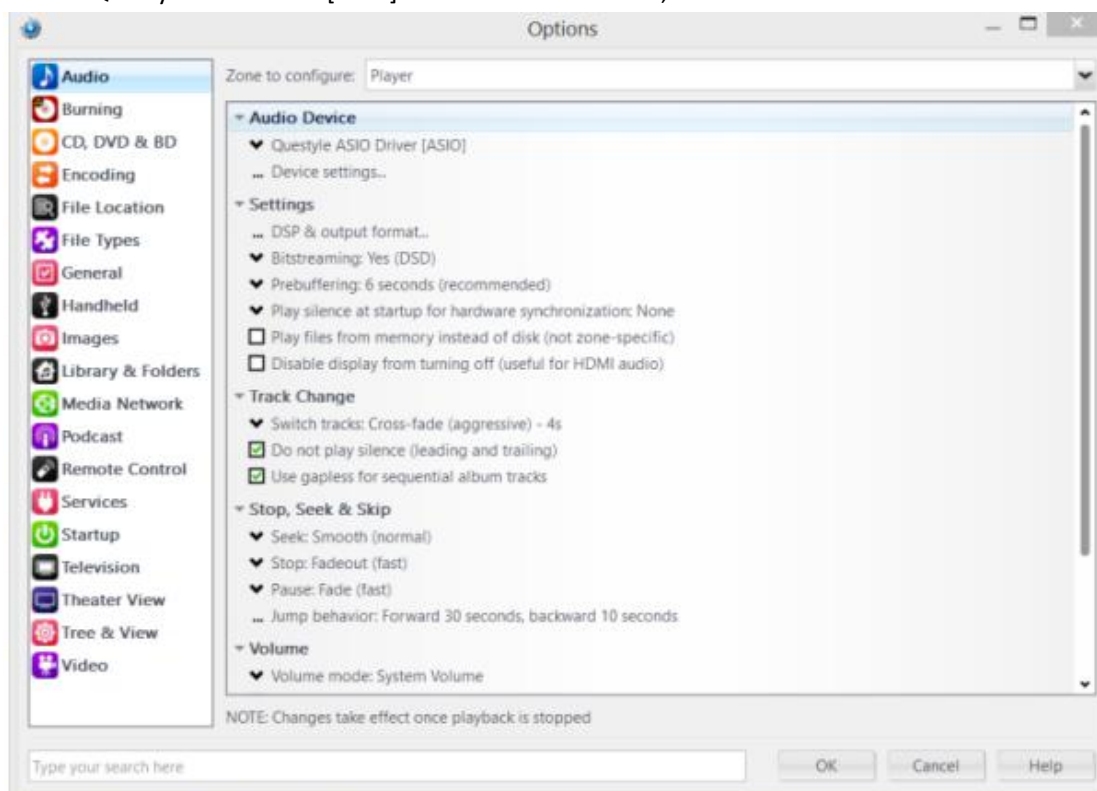

- 5) Select "Device Settings" under "Audio Device", and click "Open Driver Control Panel" under

the ASIO, then select "Format"->"2Channels, 24 Bits";select "Buffer Settings"->"Safe", "Auto"; then close and click "OK".

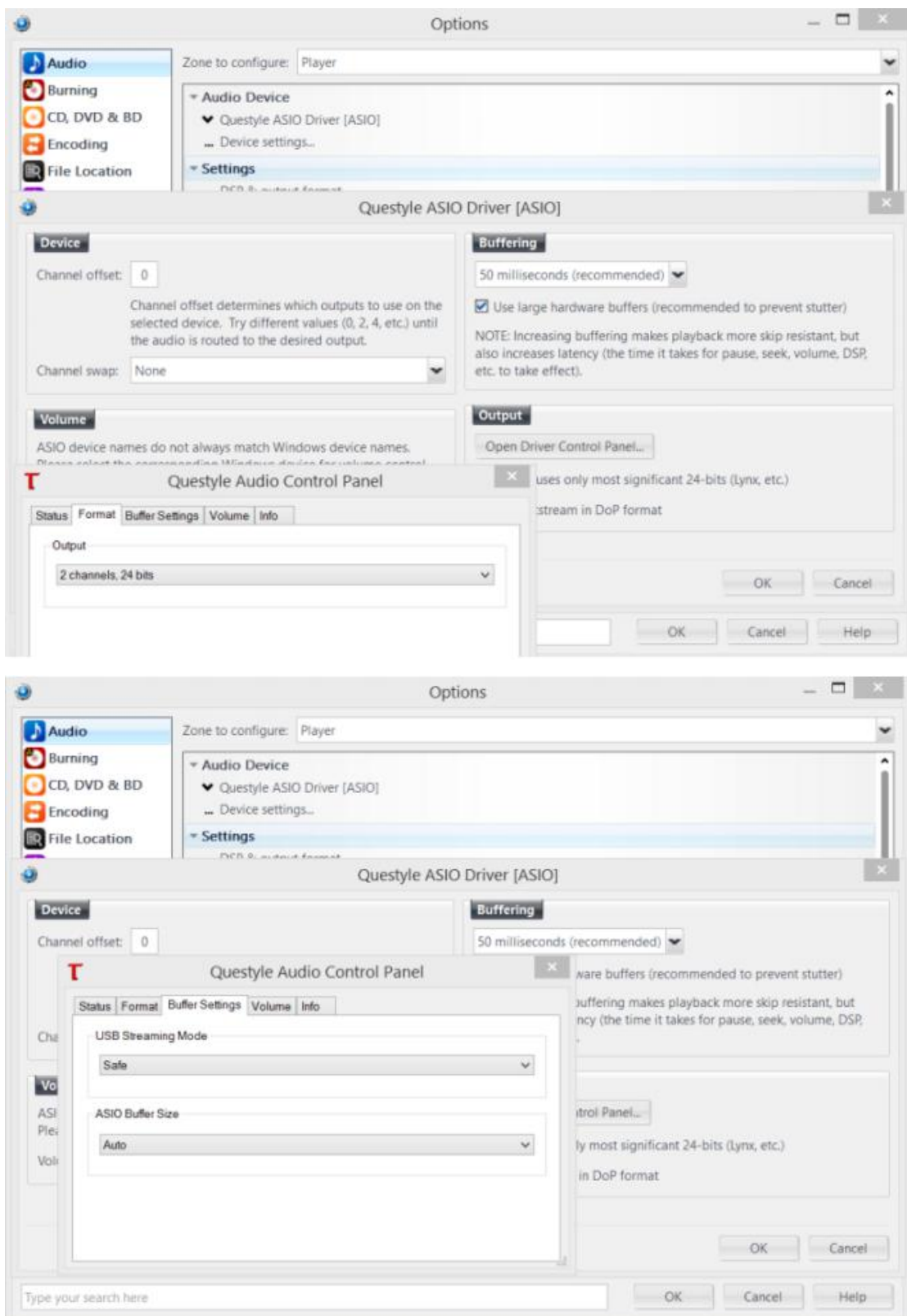

- Click "DSP& output format" under "Settings". Make sure nothing on the left row is ticked.(To wit:without any processing to DSD data, ensuring original sound.)

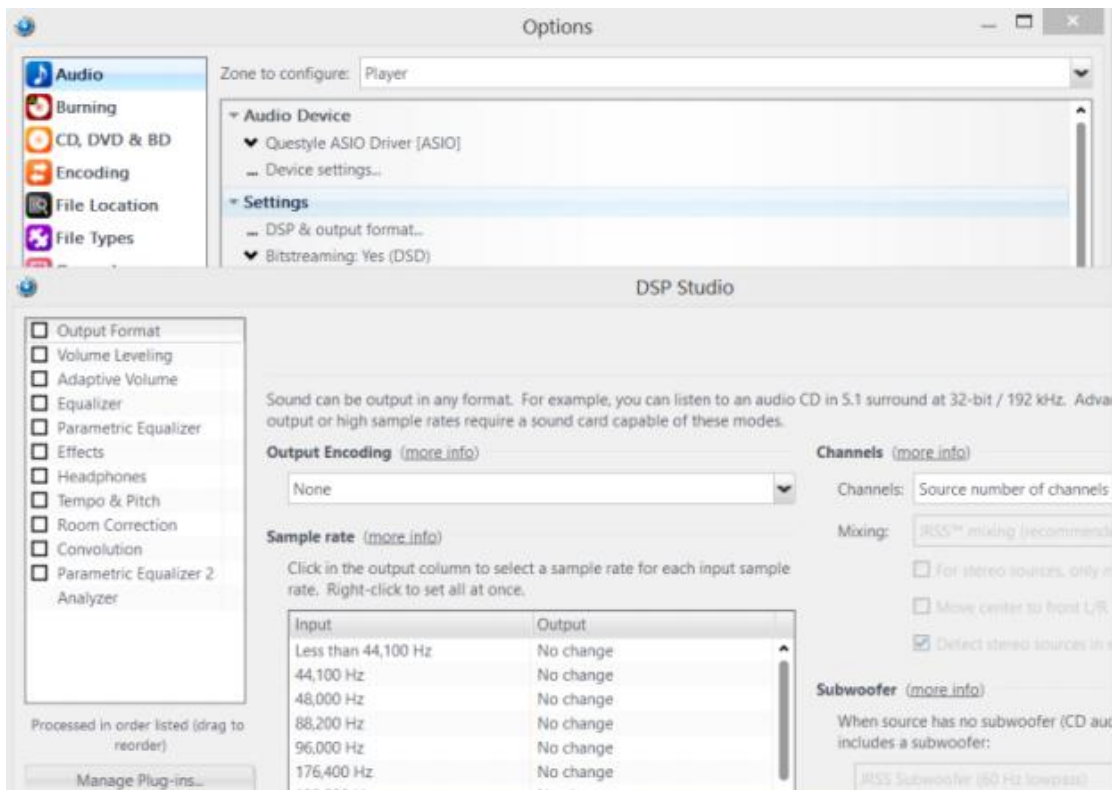

7) Select "Custom" under "Bitstreaming: Yes(DSD)"

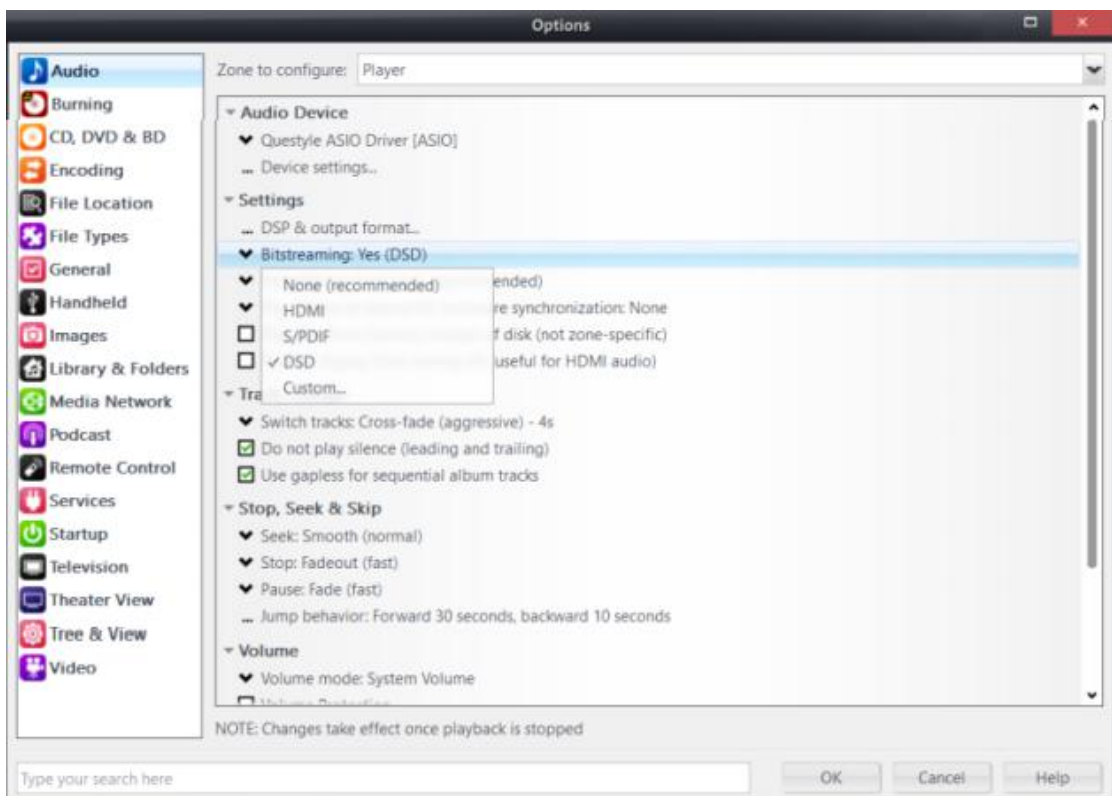

8) Tick "DSD" and then click "OK".

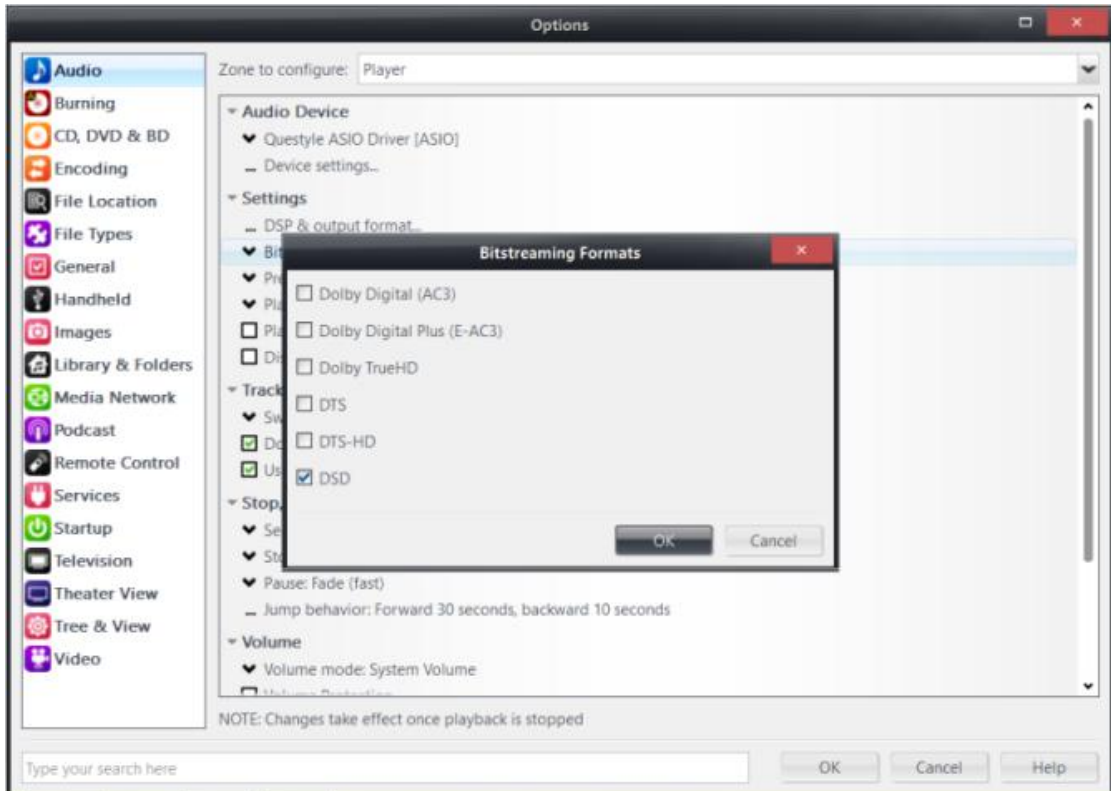

Save and exit. The setup is completed.

- 9) With a song playing, put the mouse at where the arrow is pointing to view current input and output.

